

CPM 6161

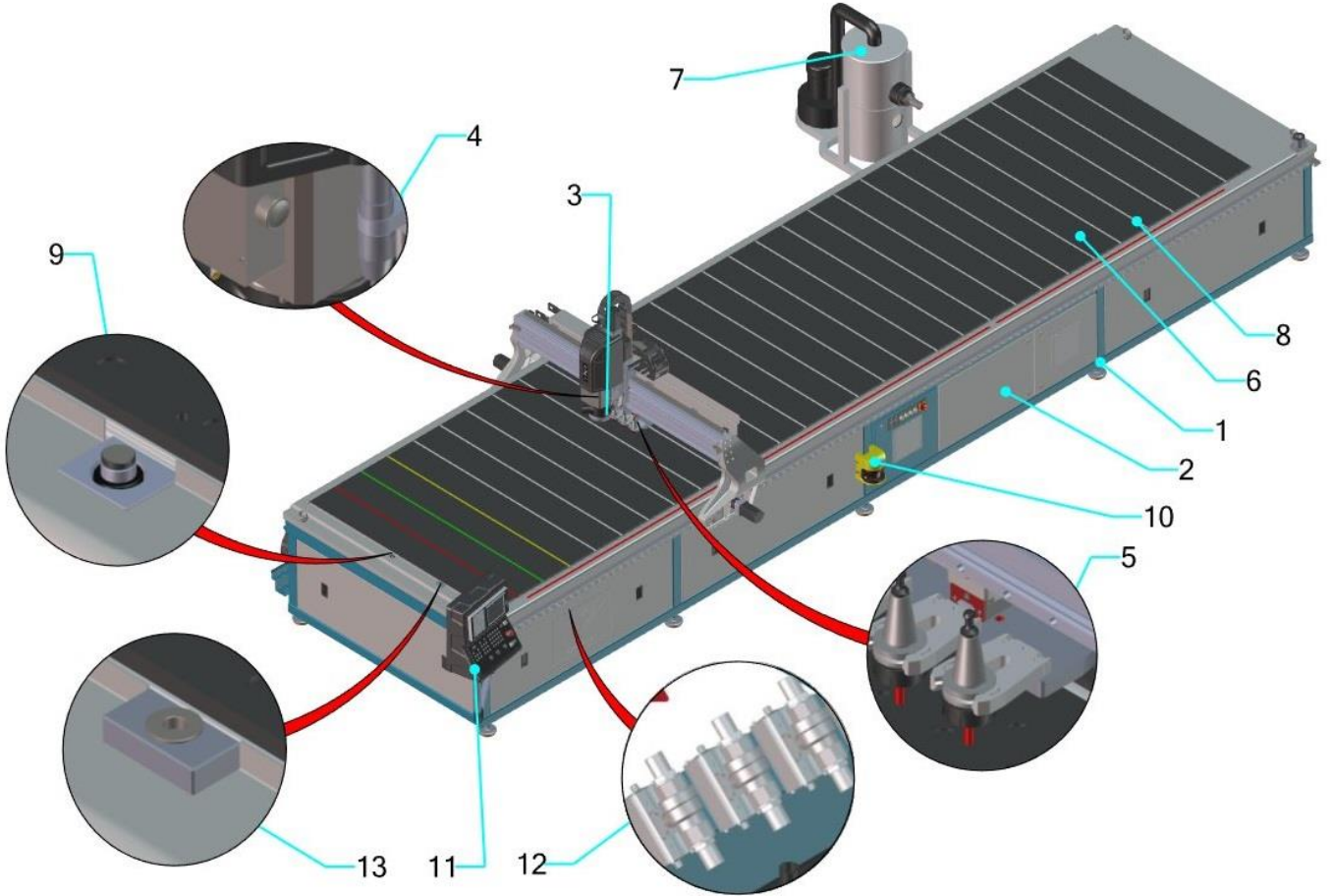

KOMPOZİT PANEL İŞLEME MAKİNESİ COMPOSITE PANEL MACHINING CENTER

PARÇA LİSTESİ - PART LIST



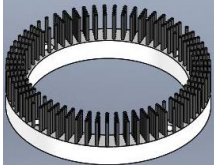

1	Ana Gövde Main Body	8	LED Efektler LED Lights
---	------------------------	---	----------------------------

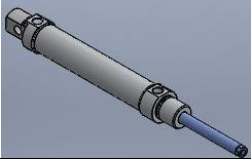
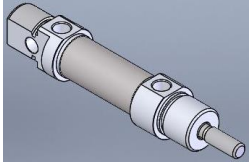
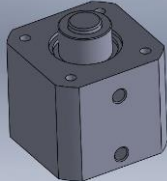
2	Elektrik Panosu Electricity Panel	9	Otomatik Takım Boyu Ölçme Automatic Tool Measurement
3	Talaş Emici Vakum Kafa Vacuumed Chip Removal Manifold	10	Işık Bariyeri Light Barrier
4	İş mili Spindle	11	Kumanda Paneli Control Panel
5	Takım Magazinlik Tool Magazine	12	Vakum Tablası On/Off Valfleri Vacuum Table On/Off Valves
6	Panel Vakum Tablası Vacuum Table	13	Dayama Pistonu Support Piston
7	Talaş Emici Kafa Chip Removal Manifold		

YEDEK PARÇA LİSTESİ / SPARE PART LIST / СПИСОК ЗАПАСНЫХ ЧАСТЕЙ			
PARÇA NO PART NO НОМЕР	RESİM PICTURE РИСУНОК	STOK KODU / CODE ПОРЯДОК КОД	PARÇA ADI – PART NAME НАИМЕНОВАНИЕ ДЕТАЛИ
1		1PL010000-0079	HALKA FIRÇA (CPM 4150)
2		1SK050000-0402 1SK050000-1001	KESİCİ TAKIMLAR
3		1PN020000-0234	PİSTON PMY-A 25x93
4		1PN020000-0267	PİSTON PM 20*15 (CPM 4160)
5		1PN020000-0263	PİSTON SPC 20x15 SEGMANLI SİLİNDİR (CPM 4150)

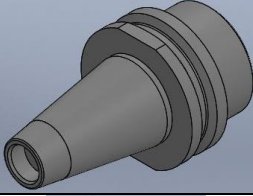
6		1PN130000-0020	KÜRESEL VANA
7		1EL210000-0122	PE KORUGE VAKUM HRT. 50MM 15 MT
8		1EL020000-0250	SENSÖR NBB2-8GM25-E2-V3 (052019)PNP-NO KONNEKTÖR
9		1PN010000-0012	SU PÜSKÜRTME DP2005 03.009.4 AZ
10		OKT060000-0648	ÇATAL ISO 30
11		1EL070020-0050	VAKUM FİLTRESİ 2.5" PVR (MENZİL)
12		1EL200000-0125	SENSÖR SMT-8M-A-PS-24V-E- 0,3-M8D
13		1PN010000-0110	VALF TEK BOBİNLİ HAFNER 1/8-5/2
14		1SK050000-0027	TAKIM TUTUCU ISO 30 PULL STUD

15		1SK050000-0026	TAKIM TUTUCU ISO 30 ER32 PENS KAFA
16		1PN010000-0510	TRPA.2014.780.A1 (12154243) AKT.KÜR.V.SETİ